

SERVICE MANUAL

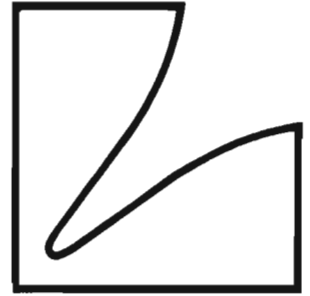

Stereo Power Amplifier

M-113



Contents

Specifications	2
Parts Location and Disassembly Instruction	3 to 5
Adjustment Procedures	6
Adjustment Location	7
Block Diagram	8
Schematic Diagram	9 to 11
Parts Layout on P.C. Boards & Wiring diagram	12 to 14
Electrical Parts List	15 to 17
Cabinet Assembly Parts List	18
Exploded View (Cabinet)	19 to 20
Packing Assembly Parts List	21
Packing Method View	22
Semi-Conductor Lead Identifications	23 to 24

Specification

Power Supply	AC120V/60Hz
Power Consumption	3.9A
Load Impedance	8 ohm
Power Output (at 0.03% THD, 8 ohm, 20Hz~20kHz).....	60 W
Max. Power Output (4 ohm, 1kHz)	100 W
T.H.D. (Input 1V at 50W Output, 8 ohm, 20Hz~20kHz)	0.33%
Input Sensitivity (at 50W Output, 8 ohm, 1kHz)	1V±20%
Input Impedance (1kHz).....	42 kohm±20%
Frequency Response (at 1W Output, 8 ohm).....	20Hz~20kHz +0, -0.3 dB
	5Hz~100kHz $\begin{matrix} +0 \\ -1.3 \end{matrix}$ dB $\begin{matrix} +0.5 \\ -2.2 \end{matrix}$ dB
S/N Ratio (Input Terminal Shorted, 8 ohm)	105 dB
Cross Talk (at 50W Output, 8 ohm, 1kHz)	70 dB
Semiconductors	3ICs, 42 Transistors, 4 FETs , 25 Diodes, 7 Zener Diodes
Dimension	483(W) x 137(H) x 365(D) mm
Weight	8.5 Kg

Parts Locations and Disassembly Instructions



Figure 1

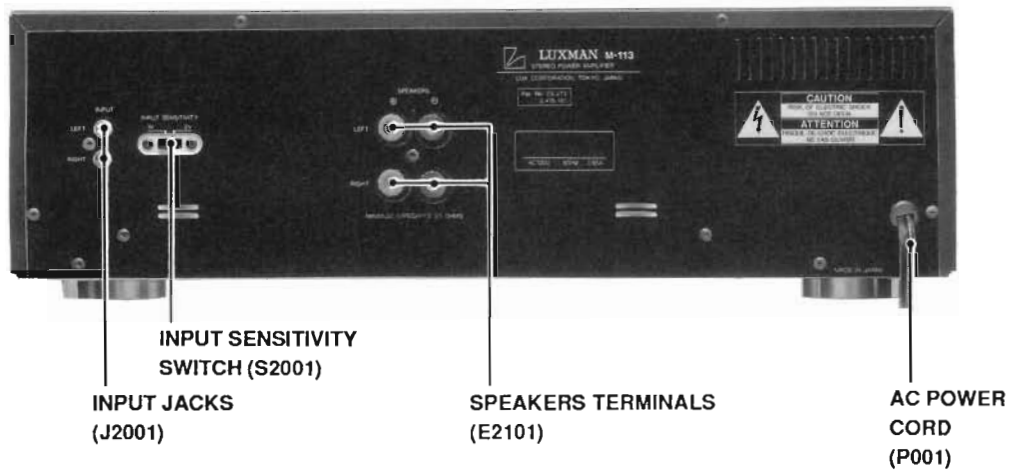

Figure 2

1. Removal of Top Cover

- (1) Remove six screws marked "●" as shown Figure 3.
- (2) Pull out the top cover in the direction of the arrow as shown in Figure 3.

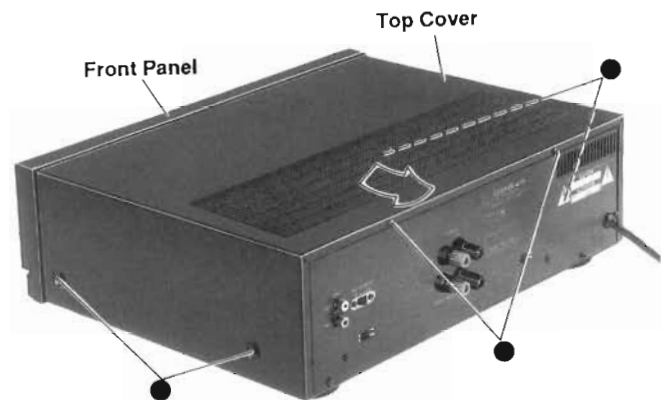

Figure 3

2. Removal of Front Panel

- (1) Remove six screws marked "▲" as shown in Figure 4.
- (2) Pull out the front panel.

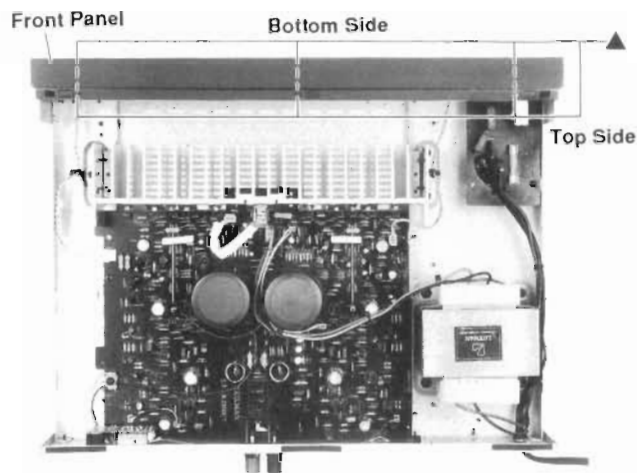

Figure 4

3. Removal of Main P.C. Board

- (1) After removal of the top cover, and the front panel, remove twelve screws marked "O" as shown in Figures 6,7 and 8.
- (2) Disconnect all connectors from the main p.c. board
- (3) Main P.C. Board with the heat sink and input p.c. board can be removed completely.

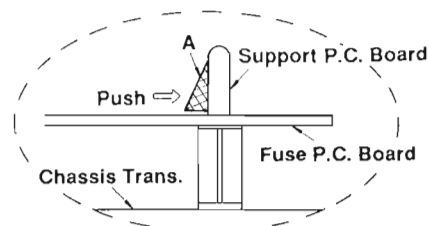

Figure 5

4. Removal of Heat Sink

- (1) After removal of the main p.c. board, remove two screws marked "x" as shown in Figure 9.
- (2) Remove the solder (A) as shown in Figure 9.
- (3) Disconnect a connector from the thermal protector p.c. board.

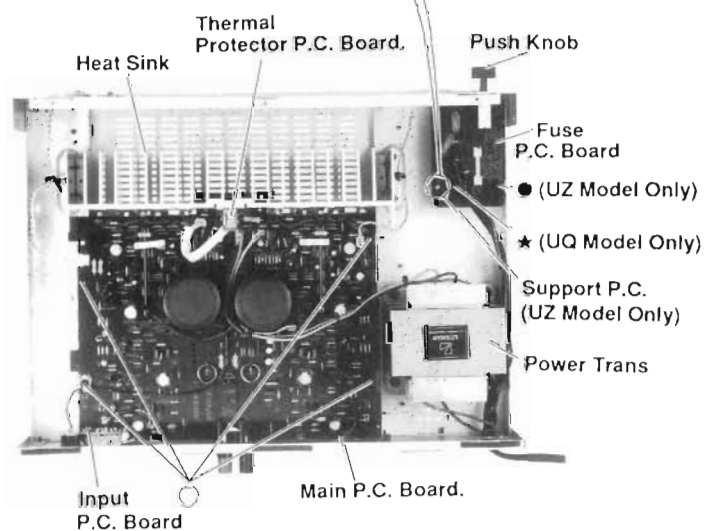

Figure 6

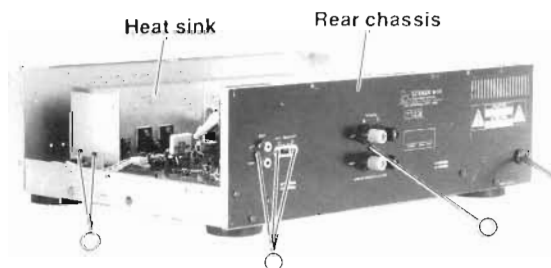

Figure 7

5. Removal of Fuse P.C. Board (UZ Model only).

- (1) After removal of the top cover and front panel, remove the push knob as shown in Figure 6.
- (2) Remove three screws marked "●" as shown in Figures 6 and 10.
- (3) Remove the PCB support from the fuse p.c. board as shown in Figure 1, by pushing the point "A" as shown in Figure 5.
- (4) Disconnect all lead wires from the fuse p.c. board.

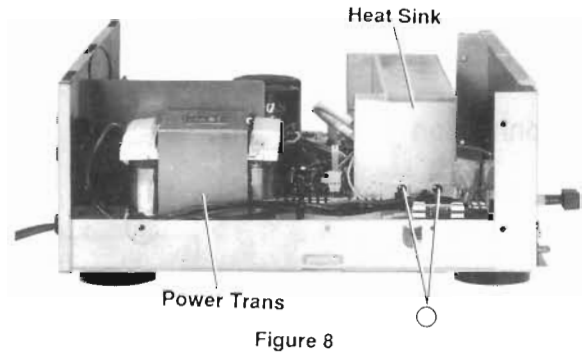

Figure 8

6. Removal of Fuse P.C. Board (UQ Model only)

- (1) After removal of the top cover and front panel, remove the push knob as shown in Figure 6.
- (2) Remove three screws marked "★" as shown in Figures 6 and 10.
- (3) Disconnect all lead wires from the fuse p.c. board.

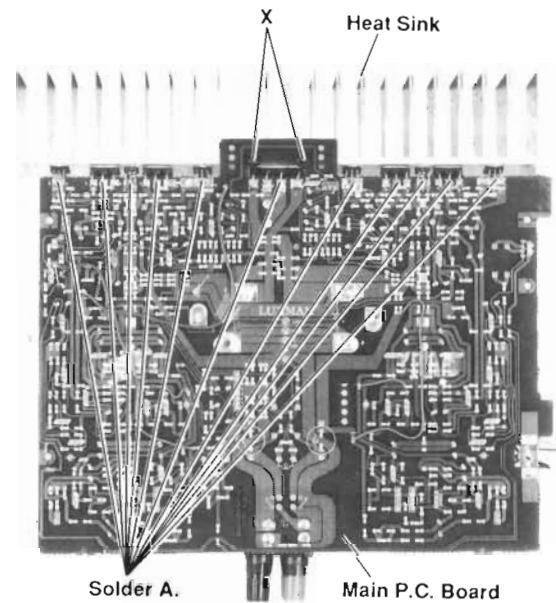

Figure 9

- (UZ Model Only)
- ★ (UQ Model Only)



Figure 10

Adjustment Procedures

1. Connection

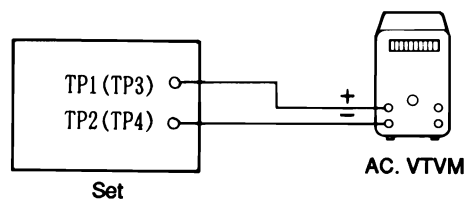

Figure 11

2. Control Setting

Power Switch _____ ON
Input Sensitivity Select Switch _____ 1V

3. Adjustment Procedures

Idling Adjustment

Adjust VR2101 (VR2102) so that voltage between TP1 (TP3) and TP2 (TP4) reaches $20 \pm 4\text{mV}$.

Note: Proceed the adjustment shown above about three minutes after power is turned on.

Adjustment Location

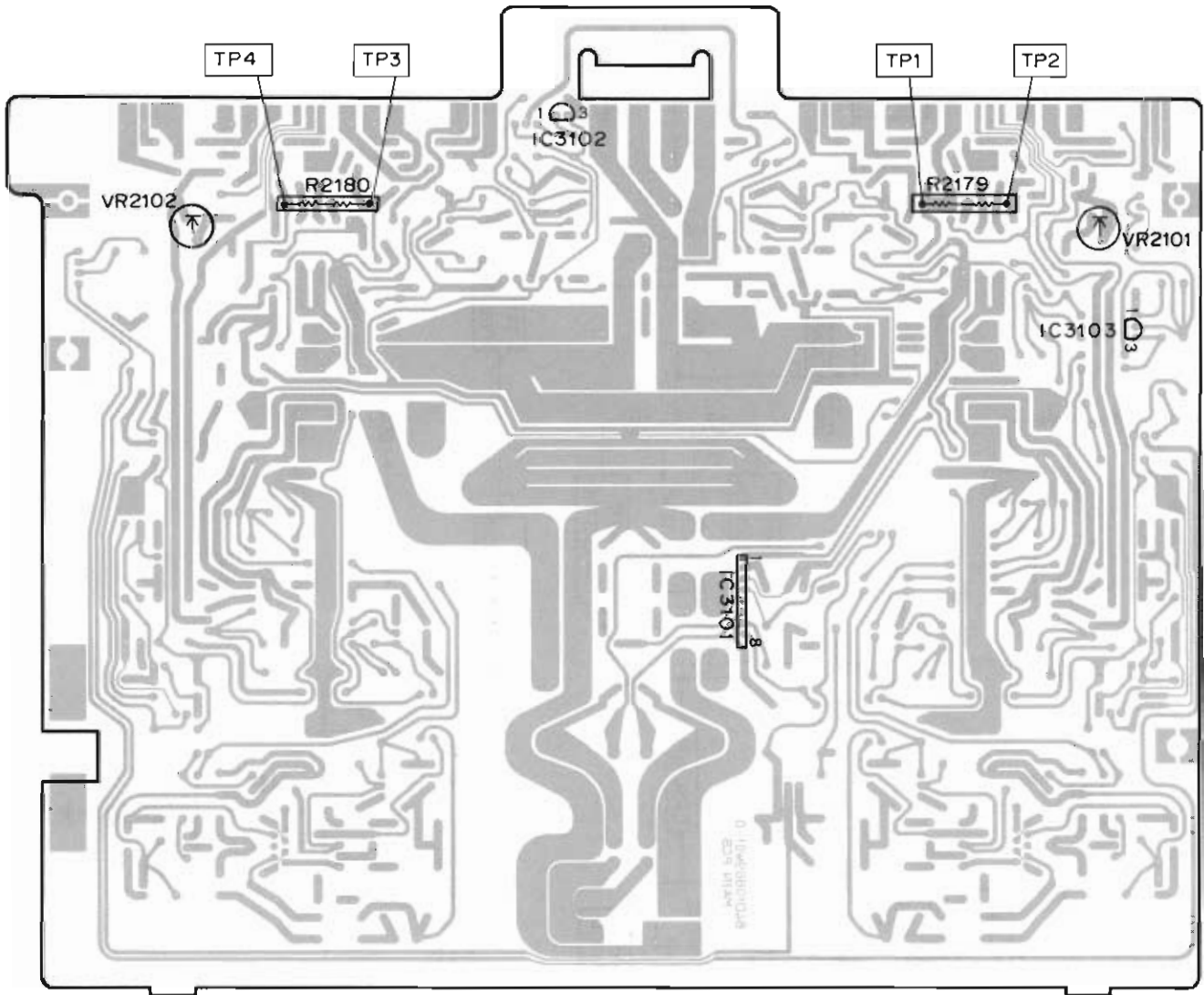
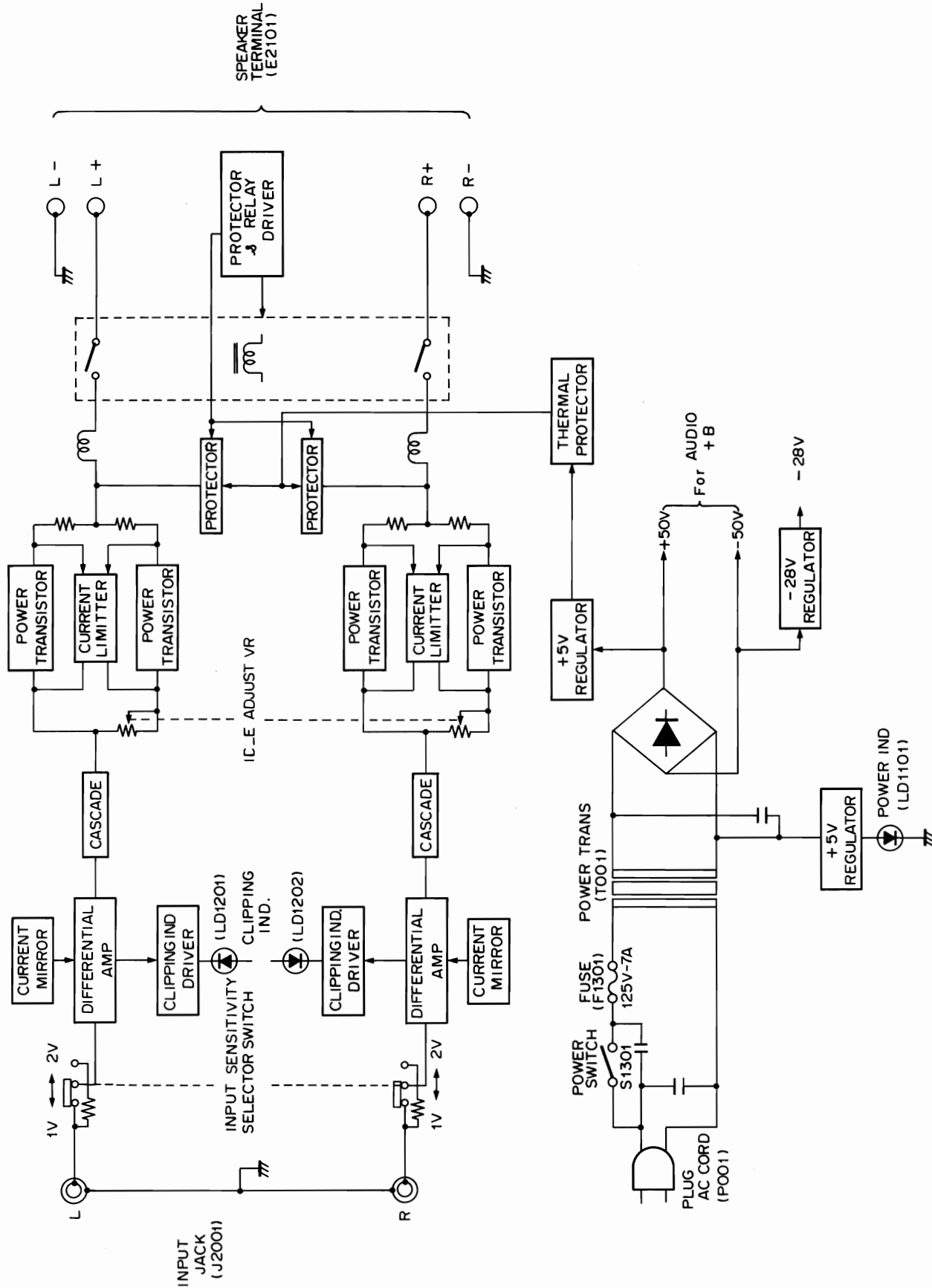

Figure 12 Main P.C. Board (Components Side)

Block Diagram



Schematic Diagram

IC'S	IC3101												IC3102		IC3103		Q5101		Q4101																																																								
TRANSISTORS (Q)	Q2101	Q2108	Q2109	Q2111	Q2118	Q2120	Q2127	Q2122	Q2123	Q2131	Q2125	Q2135	Q2139	Q2101	Q2145	Q2146				Q2103	Q2106	Q2110	Q2113	Q2116	Q2119	Q2129	Q2130	Q2124	Q2133	Q2126	Q2137	Q2141	Q2145	Q2146					Q2105	Q2104	Q2107	Q2115	Q2114	Q2117	Q2121	Q2125	Q2124	Q2132	Q2128	Q2136	Q2140	Q2146						Q2102			Q2112	Q2112													
	Q2103	Q2106	Q2110	Q2113	Q2116	Q2119	Q2129	Q2130	Q2124	Q2133	Q2126	Q2137	Q2141	Q2145	Q2146					Q2105	Q2104	Q2107	Q2115	Q2114	Q2117	Q2121	Q2125	Q2124	Q2132	Q2128	Q2136	Q2140	Q2146						Q2102			Q2112	Q2112																																
	Q2105	Q2104	Q2107	Q2115	Q2114	Q2117	Q2121	Q2125	Q2124	Q2132	Q2128	Q2136	Q2140	Q2146						Q2102			Q2112	Q2112																																																			
	Q2102			Q2112	Q2112																																																																						

NOTE
 1. All resistance values are in ohms. K=1,000 M=1,000,000
 2. All capacitance values are in microfarads. P=1/100,000,000
 Measuring Condition
 1 Power Supply Voltage : AC120V
 2 Measuring Meter : Digital Multi Voltmeter
 3 Measuring Point Reference: From Capacitor 1402 to 1403 On the Line
 4 Measuring conditions : Power SW/ON No Signal Input

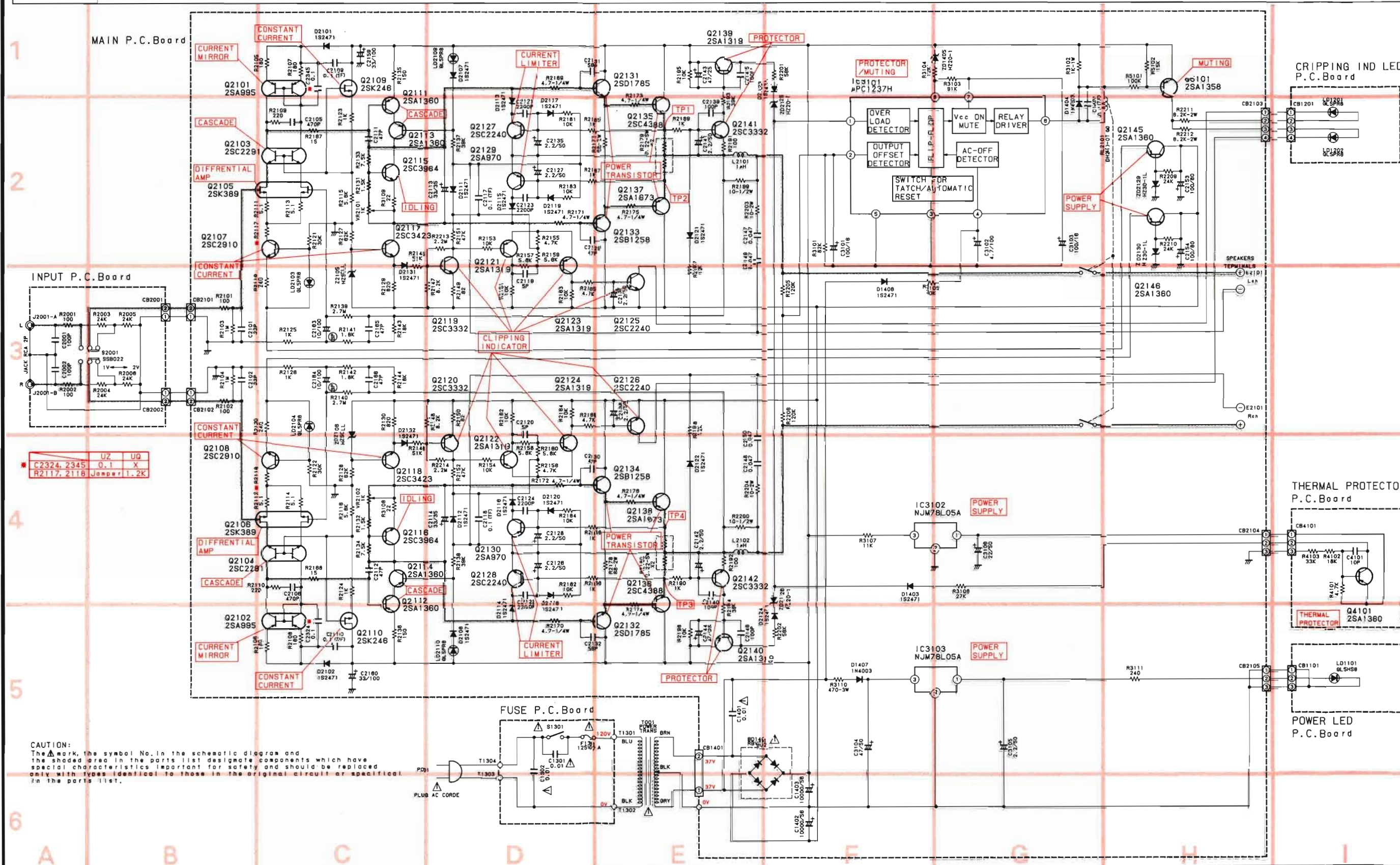

	IC3101	IC3102	IC3103
1	0V	5V	5V
2	0V	0V	0V
3	0V	50V	27V
4	1.6V		
5	0V		
6	1V		
7	2.2V		
8	3.2V		

	E	C	B
Q4101	5V	0V	4.4V
Q5101	50V	48V	49.4V

	E	L	C	B
Q2101	49V	48.7V	48V	48V
Q2103	-	48.7V	4.8V	4.8V
Q2107	-26.6V	-0.2V	-26V	-26V
Q2111	48V	48V	48.7V	48.7V
Q2113	48V	1.7V	47.4V	47.4V
Q2115	-1.7V	1.7V	-	-
Q2117	-45.6V	-1.7V	-45V	-45V
Q2119	-50V	-	-49V	-49V
Q2121	-13V	-13V	-14V	-14V
Q2123	-13V	-50V	-8.8V	-8.8V
Q2125	-50V	48V	-	-
Q2127	0V	-	0V	0V
Q2129	0V	-	0V	0V
Q2131	0.6V	50V	1.7V	1.7V
Q2133	-0.6V	-50V	-1.7V	-1.7V
Q2135	0V	50V	0.6V	0.6V
Q2137	0V	-50V	-0.6V	-0.6V
Q2139	50V	0V	49V	49V
Q2141	0V	1.5V	0V	0V
Q2145	-28V	-50V	-27.4V	-27.4V

	E	R	C	B
Q2102	49V	48.7V	48.4V	48.4V
Q2104	-	48.7V	4.8V	4.8V
Q2108	-26.6V	-0.2V	-26V	-26V
Q2112	48V	48V	48.7V	48.7V
Q2114	48V	1.7V	47.4V	47.4V
Q2116	-1.7V	1.7V	-	-
Q2118	-45.6V	-1.7V	-45V	-45V
Q2120	-50V	-	-49V	-49V
Q2122	-13V	-13V	-14V	-14V
Q2124	-13V	-50V	-8.8V	-8.8V
Q2126	-50V	48V	-	-
Q2128	0V	-	0V	0V
Q2130	0V	-	0V	0V
Q2132	0.6V	50V	1.7V	1.7V
Q2134	-0.6V	-50V	-1.7V	-1.7V
Q2136	0V	50V	0.6V	0.6V
Q2138	0V	-50V	-0.6V	-0.6V
Q2140	50V	0V	49V	49V
Q2142	0V	1.5V	0V	0V
Q2146	-28V	-50V	-27.4V	-27.4V

	S	D	G
Q2105	-0.2V	-	0V
Q2109	5.7V	50V	0V

	S	D	G
Q2106	-0.2V	-	0V
Q2110	5.7V	50V	0V

CAUTION:
 The symbol No. in the schematic diagram and the shaded area in the parts list designate components which have special characteristics important for safety and should be replaced only with types identical to those in the original circuit or specified in the parts list.

- BLU Blue
- GRN Green
- BLK Black
- GRY Gray
- WHT White
- RED Red
- YEL Yellow
- VIO Violet
- BLK/WHT Black/White
- SHLD Shield

Parts Layout on P.C. Board & Wiring Diagram

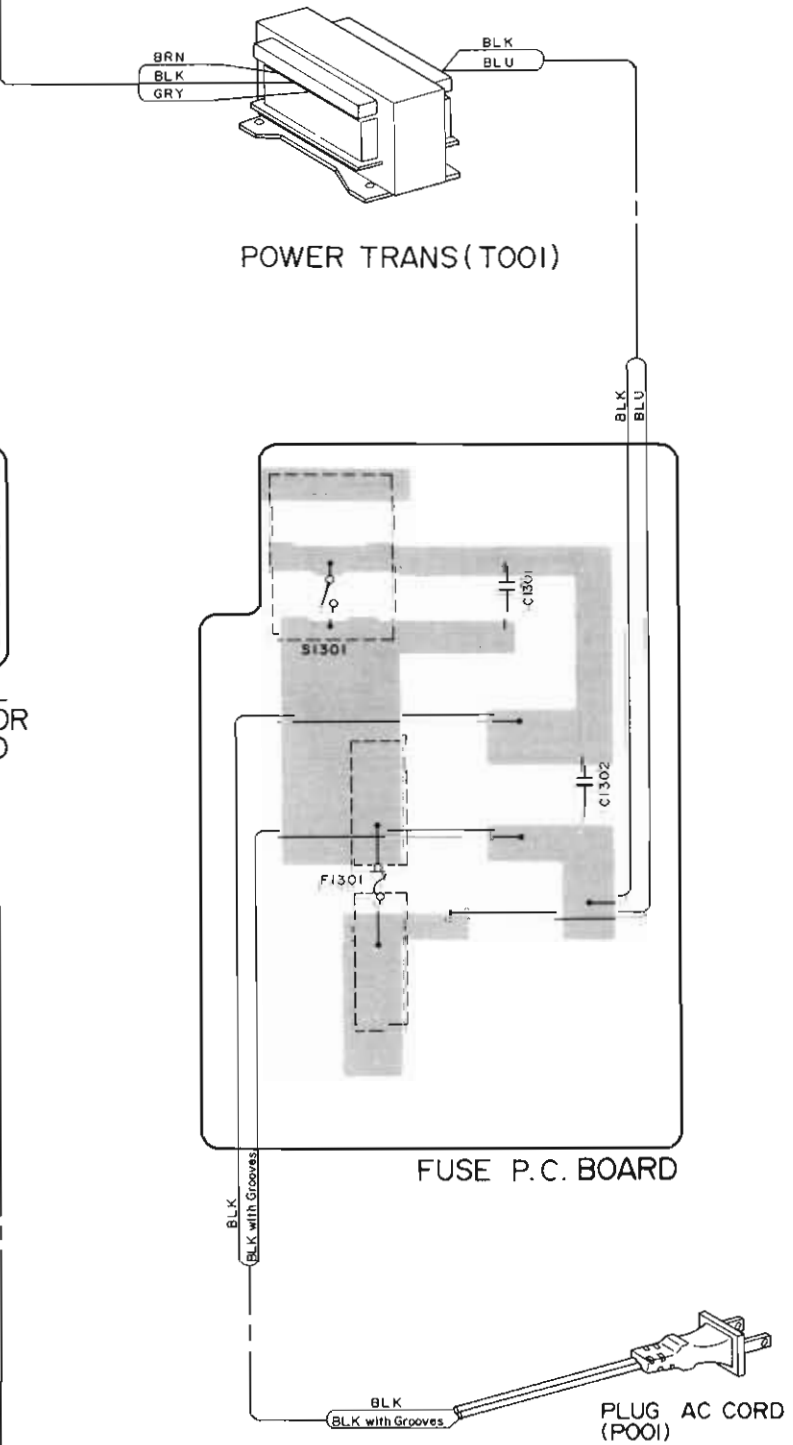
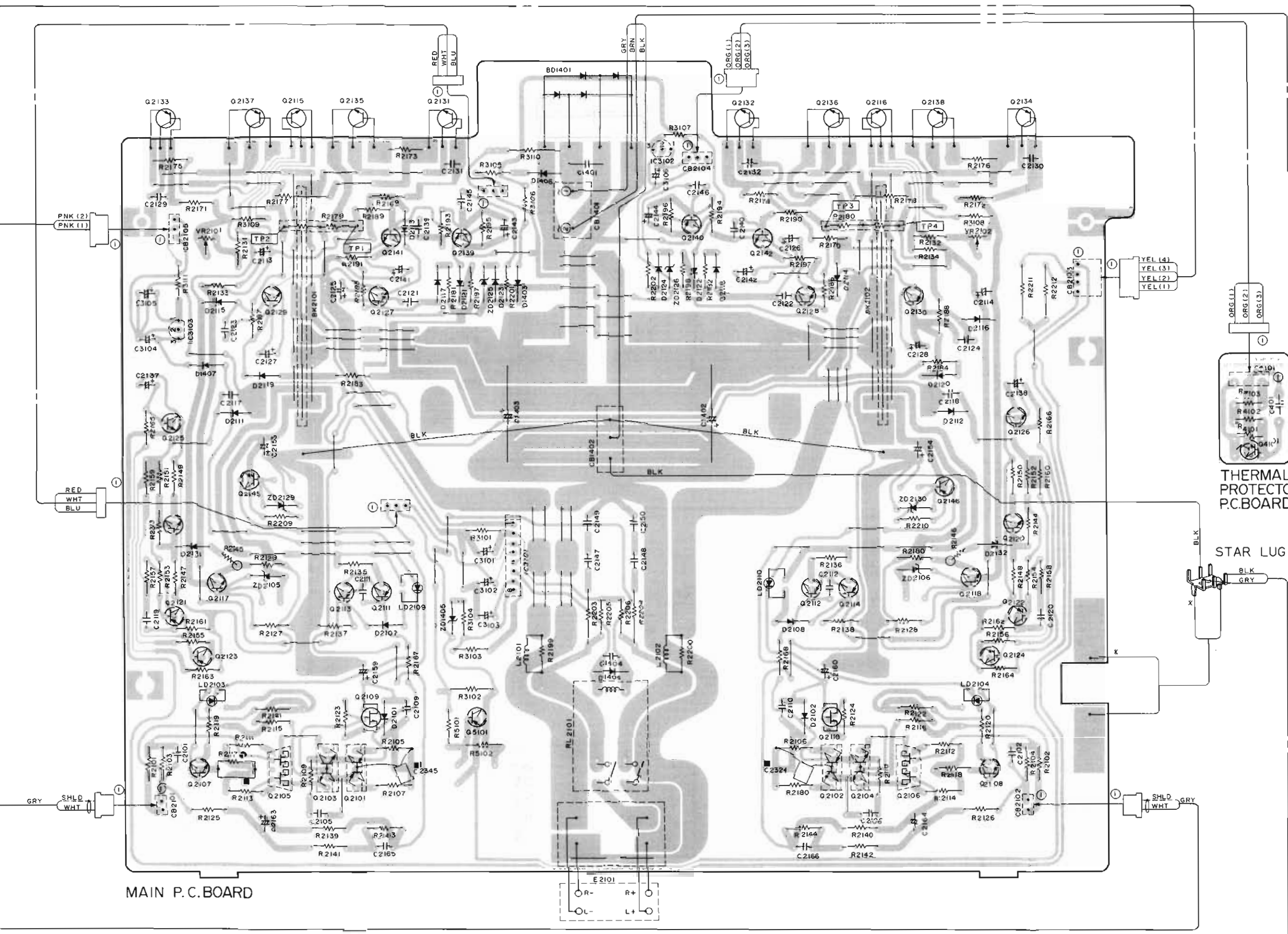
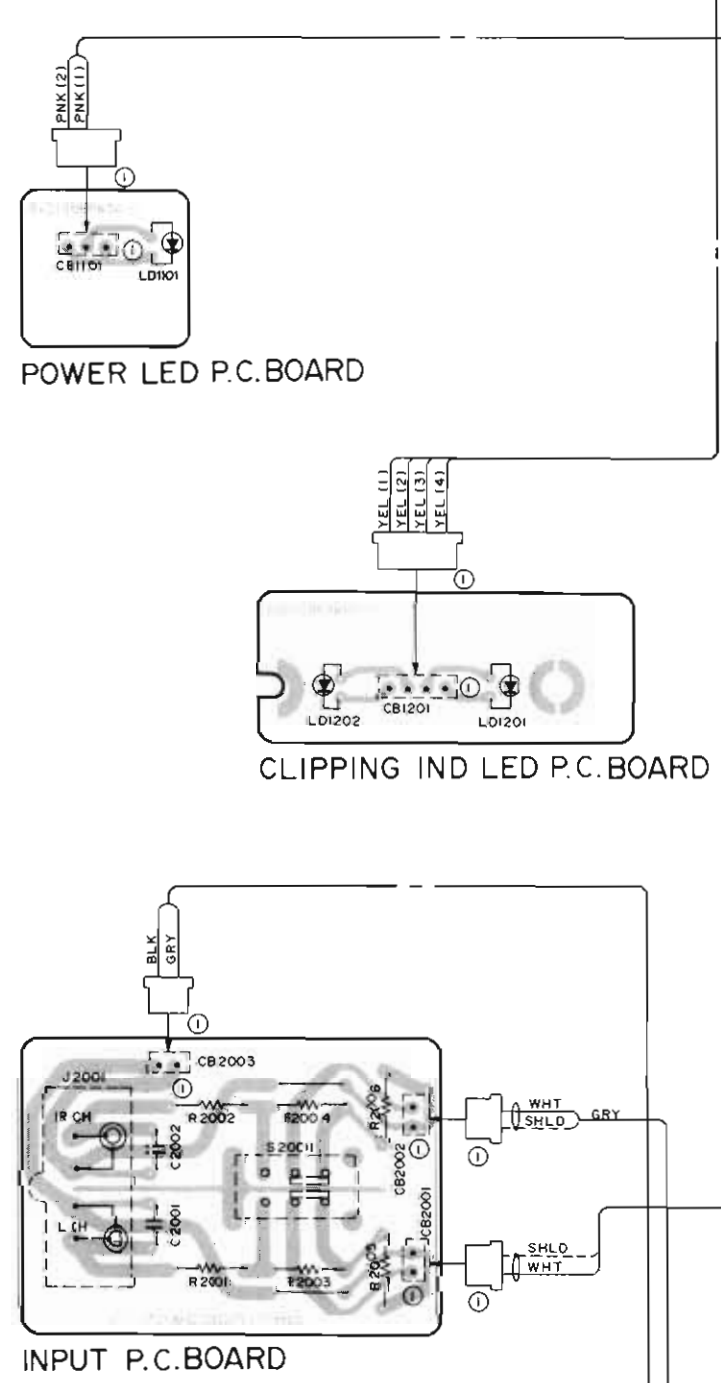

	UZ	UQ
C2324, 2345	0.1	X
R2117, 2118	Jumper	1.2K

● : UQ MODEL ONLY
 ■ : UZ MODEL ONLY
 Others : COMMON

Electrical Parts List

Resistor: Carbon resistors under 1/8 watts are not mentioned in the parts list. please confirm them by schematic diagram.

Capacitor: μ F-microfarads, pF-picofarads

Abbreviations			
CAP.-Capacitor	CER.-Ceramic		
CP.-Chip	LED.-Light Emitting Diode		
ELY.-Electrolytic	MO.-Metal Oxide Film		
MIC.-Mica	PP.-Polypropylene		
MYL.-Mylar	ZEN.-Zener		
SOL.-Solid			
Symbol No.	Part No.	Description	
Main P.C.Board			
IC's			
IC3101	51T60527F01	μ PC1237H	
IC3102	51T61180F02	NJM78L05A	
IC3103	51T61180F02	NJM78L05A	
Transistors			
Q2101	48T72597F01	2SA995	
Q2102	48T72597F01	2SA995	
Q2103	48T72598F01	2SC2291	
Q2104	48T72598F01	2SC2291	
Q2105	48T61719F01	FET. 2SK389	
Q2106	48T61719F01	FET. 2SK389	
Q2107	48T72889F01	2SC2910	
Q2108	48T72889F01	2SC2910	
Q2109	48T66948F03	FET. 2SK246	
Q2110	48T66948F03	FET. 2SK246	
Q2111	48T64375F01	2SA1360	
Q2112	48T64375F01	2SA1360	
Q2113	48T64375F01	2SA1360	
Q2114	48T64375F01	2SA1360	
Q2117	48T64376F01	2SC3423	
Q2118	48T64376F01	2SC3423	
Q2119	48T82195F01	2SC3332S	
Q2120	48T82195F01	2SC3332S	
Q2121	48T82194F01	2SA1319S	
Q2122	48T82194F01	2SA1319S	
Q2123	48T82194F01	2SA1319S	
Q2124	48T82194F01	2SA1319S	
Q2125	48T53301F01	2SC2240	
Q2126	48T53301F01	2SC2240	
Q2127	48T53301F01	2SC2240	
Q2128	48T53301F01	2SC2240	
Q2129	48T52545F01	2SA970	
Q2130	48T52545F01	2SA970	
Q2139	48T82194F01	2SA1319S	
Q2140	48T82194F01	2SA1319S	

Symbol No.	Part No.	Description		
Q2141	48T82195F01	2SC3332S		
Q2142	48T82195F01	2SC3332S		
Q2145	48T64375F01	2SA1360		
Q2146	48T64375F01	2SA1360		
Q5101	48T69177F01	2SA1358		
Diodes/LEDs				
D1403	48T68764F01	1S2471		
D1404	48S40477U01	1N4003		
D1406	48T68764F01	1S2471		
D1407	48S40477U01	1N4003		
D2101	48T68764F01	1S2471		
D2102	48T68764F01	1S2471		
D2107	48T68764F01	1S2471		
D2108	48T68764F01	1S2471		
D2111	48T68764F01	1S2471		
D2112	48T68764F01	1S2471		
D2113	48T68764F01	1S2471		
D2114	48T68764F01	1S2471		
D2115	48T68764F01	1S2471		
D2116	48T68764F01	1S2471		
D2117	48T68764F01	1S2471		
D2118	48T68764F01	1S2471		
D2119	48T68764F01	1S2471		
D2120	48T68764F01	1S2471		
D2121	48T68764F01	1S2471		
D2122	48T68764F01	1S2471		
D2123	48T68764F01	1S2471		
D2124	48T68764F01	1S2471		
D2131	48T68764F01	1S2471		
D2132	48T68764F01	1S2471		
ZD1405	48T52739F85	ZEN. HZ20-1		
ZD2105	48T62636F12	ZEN. HZ5CLL		
ZD2106	48T62636F12	ZEN. HZ5CLL		
ZD2125	48T52739F85	ZEN. HZ20-1		
ZD2126	48T52739F85	ZEN. HZ20-1		
ZD2129	48T52741F67	ZEN. HZ30-1		
ZD2130	48T52741F67	ZEN. HZ30-1		
LD2103	48T10857W01	LED. GL5PR8 (RED)		
LD2104	48T10857W01	LED. GL5PR8 (RED)		
LD2109	48T10857W01	LED. GL5PR8 (RED)		
LD2110	48T10857W01	LED. GL5PR8 (RED)		

Symbol No.	Part No.	Description			Symbol No.	Part No.	Description		
Capacitors									
■	C1401	21T68834F01	CER.	0.01 μ F		C2150	08T57851F09	TF.	0.047 μ F
●	C1402	23T10976W01	ELY.	10.000 μ F/56V		C2153	23T00132L42	ELY.	100 μ F/80V
●	C1402	23T15908W01	ELY.	10.000 μ F/56V		C2154	23T00132L42	ELY.	100 μ F/80V
■	C1403	23T10976W01	ELY.	10.000 μ F/56V		C2159	23T00132L53	ELY.	33 μ F/100V
●	C1403	23T15908W01	ELY.	10.000 μ F/56V		C2160	23T00132L53	ELY.	33 μ F/100V
	C1404	08T57851F13	TF.	0.1 μ F		C2163	23T81031F05	ELY.	(BP)10 μ F/100V
	C2101	08T81196F14	MIC.	22pF		C2164	23T81031F05	ELY.	(BP)10 μ F/100V
	C2102	08T81196F14	MIC.	22pF		C2165	08T81196F25	MIC.	47pF
	C2105	08T93192F41	ENQ.	470pF		C2166	08T81196F25	MIC.	47pF
	C2106	08T93192F41	ENQ.	470pF	■	C2324	08T50579F13	TF.	0.1 μ F
	C2109	08T57851F13	TF.	0.1 μ F	■	C2345	08T50579F13	TF.	0.1 μ F
	C2110	08T57851F13	TF.	0.1 μ F		C3101	23T00138L21	ELY.	100 μ F/16V
	C2111	08T81196F25	MIC.	47pF		C3102	23T00138L75	ELY.	4.7 μ F/100V
	C2112	08T81196F25	MIC.	47pF		C3103	23T00138L21	ELY.	100 μ F/16V
	C2113	23T00149L44	ELY.	33 μ F/35V		C3104	23T00149L59	ELY.	47 μ F/50V
	C2114	23T00149L44	ELY.	33 μ F/35V		C3105	23T00138L46	ELY.	2.2 μ F/50V
	C2117	08T57851F13	TF.	0.1 μ F		C3106	23T00138L46	ELY.	2.2 μ F/50V
	C2118	08T57851F13	TF.	0.1 μ F	Resistors				
	C2119	21S40655F06	CER.	5pF		R2177	06T92264F21	MF.	68ohm 2W
	C2120	21S40655F06	CER.	5pF		R2178	06T92264F21	MF.	68ohm 2W
	C2121	08T00152L13	P.P.	2.200pF		R2179	06T67397F01	MPC.	0.22ohm 5W
	C2122	08T00152L13	P.P.	2.200pF		R2180	06T67397F01	MPC.	0.22ohm 5W
	C2123	08T00152L13	P.P.	2.200pF		R2199	06C43205J37	MF.	10ohm 1/2W
	C2124	08T00152L13	P.P.	2.200pF		R2200	06C43205J37	MF.	10ohm 1/2W
	C2125	23T00138L46	ELY.	2.2 μ F/50V		R2203	06T92264F01	MF.	10ohm 2W
	C2126	23T00138L46	ELY.	2.2 μ F/50V		R2204	06T92264F01	MF.	10ohm 2W
	C2127	23T00138L46	ELY.	2.2 μ F/50V		R2211	06T92264F71	MF.	8.2Kohm 2W
	C2128	23T00138L46	ELY.	2.2 μ F/50V		R2212	06T92264F71	MF.	8.2Kohm 2W
	C2129	08T81196F25	MIC.	47pF		R3102	06T92263F49	MF.	1Kohm 1W
	C2130	08T81196F25	MIC.	47pF		R3110	06T92265F41	MF.	470ohm 3W
	C2131	08T81196F28	MIC.	56pF		VR2101	18C41732G07	SOL.	Variable 1Kohm
	C2132	08T81196F28	MIC.	56pF		VR2102	18C41732G07	SOL.	Variable 1Kohm
	C2137	23T00138L46	ELY.	2.2 μ F/50V	Coils				
	C2138	23T00138L46	ELY.	2.2 μ F/50V		L2101	24T74372F02	IND.	1 μ H
	C2139	08T81196F34	MIC.	100pF		L2102	24T74372F02	IND.	1 μ H
	C2140	08T81196F34	MIC.	100pF	Relay				
	C2141	23T00138L46	ELY.	2.2 μ F/50V		RL2101	80T95099F02	DH24D2-OT(M)	
	C2142	23T00138L46	ELY.	2.2 μ F/50V					
	C2143	23T00138L30	ELY.	47 μ F/25V					
	C2144	23T00138L30	ELY.	47 μ F/25V					
	C2145	08T81196F34	MIC.	100pF					
	C2146	08T81196F34	MIC.	100pF					
	C2147	08T57851F09	TF.	0.047 μ F					
	C2148	08T57851F09	TF.	0.047 μ F					
	C2149	08T57851F09	TF.	0.047 μ F					

Note : ● : For Canadian model only(UQ)

■ : For North American model only(UZ)

Others ; Common

Symbol No.	Part No.	Description		
Input P.C. Board				
Capacitors				
C2001	08T61642F27	MIC.	100pF	
C2002	08T61642F27	MIC.	100pF	
Resistors				
R2001	06T00126L41	MF.	100ohm 1/4W	
R2002	06T00126L41	MF.	100ohm 1/4W	
R2003	06T00126L98	MF.	24Kohm 1/4W	
R2004	06T00126L98	MF.	24Kohm 1/4W	
R2005	06T00126L98	MF.	24Kohm 1/4W	
R2006	06T00126L98	MF.	24Kohm 1/4W	
TH-PRO P.C. Board				
Capacitor				
C4101	21S40655F11	CER.	10pF	
Miscellaneous				
BD1401	48T81924F01	Dio.Bridge RBV-602		
C1301	08T57437F09	Cap.Cer.0.01 μ F		
C1302	08T57437F09	Cap.Cer.0.01 μ F		
E2101	40T15190W01	SP-Terminal		
F1301	65T62175F01	Fuse.UL 7A-125V		
J2001	09T70753F07	Jack.RCA 2P		
LD1101	48T10857W02	LED.GL5HS8 (ORG)		
LD1201	48T10857W01	LED.GL5PR8 (RED)		
LD1202	48T10857W01	LED.GL5PR8 (RED)		
P001	28T55335F02	Plug.AC Cord		
Q2115	48T92782F01	Tr.2SC3964		
Q2116	48T92782F01	Tr.2SC3964		
Q2131	48T94821F01	Tr.2SD1785		
Q2132	48T94821F01	Tr.2SD1785		
Q2133	48T94820F01	Tr.2SB1258		
Q2134	48T94820F01	Tr.2SB1258		
Q2135	48T95042F01	Tr.2SC4388		
Q2136	48T95042F01	Tr.2SC4388		
Q2137	48T95041F01	Tr.2SA1673		
Q2138	48T95041F02	Tr.2SA1673		

Symbol No.	Part No.	Description		
Q4101	48T64375F01	Tr.2SA1360		
■ S1301	40T92255F02	Sw.Push SDDL 1P		
● S1301	40T92612F01	SW.Push SDDFA3		
S2001	40T69085F01	Sw.Slide SSB022		
T001	25T10975W01	Trans.M-113TUZ.Bando		

Note : ● ; For Canadian model only(UQ)

■ ; For North American model only(UZ)

Others ; Common

Cabinet Assembly Parts List

Note: The parts without part numbers are not supplied.

Symbol No.	IN-dex	Part No.	Description			Symbol No.	IN-dex	Part No.	Description		
1	5-A	01V13100W66	Assy..Panel Front								
2	4-B	64C10969W01	Panel.Front								
3	5-B	13B10970W01	Frame.Panel Side(L,R)								
5		03S43997P42	Screw.Countersink(M3x5)								
6	5-C	75S92415F43	Cushion.Rubber								
8	5-C	75S62361F95	Cushion.Rubber								
9	1-D	15D72658F01	Cover.Top								
11	4-H	15C10967W01	Cover.Rear								
12	3-G	43B41625J02	Support.Cord								
13	2-F	14S53018F42	Insulator.Cover								
16		03S82672F20	Screw.Bind(M3x8)								
18		03S71677F17	Screw.Bind(M3x8)								
19		03S40018G08	Screw.TPG(M3x8)								
■ 21	2-A	07A91046F03	Support.P.C.Board								
22	3-F	43A11630W01	Spacer.Earth								
23	3-H	03S82672F22	Screw.Bind(M3x10)								
24	3-H	03S82671F02	Screw.Bind(M2.6x4)								
25		03S71031F03	Screw.Bind(M3x6)								
26	1-C	03S40036U12	Screw.Pan(M4x6)								
32	3-F	29T84161F01	Star.Lug								
34	1-B	09T51960F01	Holder.Fuse								
35	4-E	03C40121T18	Screw.W/Double Washer (M3x10)								
40		03S44205G50	Screw.Countersink(M3x6)								
41	4-A	36A94152F01	Knob.Push Power								
42		75A96563F02	Pad.Trannleg(BLK)								
43		03S44205G52	Screw.Pan(M4x14)								
44		03S40036U01	Screw.Pan(M4x8)								
45	1-A	43T53136F01	Bush.Cap								
● 47	1-B	03C40121T17	Screw.W/Double Washer (M3x8)								
● 48	2-A	47C64899F72	Shaft 33.9								

Note : ● ; For Canadian model only(UQ)

■ ; For North American model only(UZ)

Others ; Common

Exploded View (Cabinet)

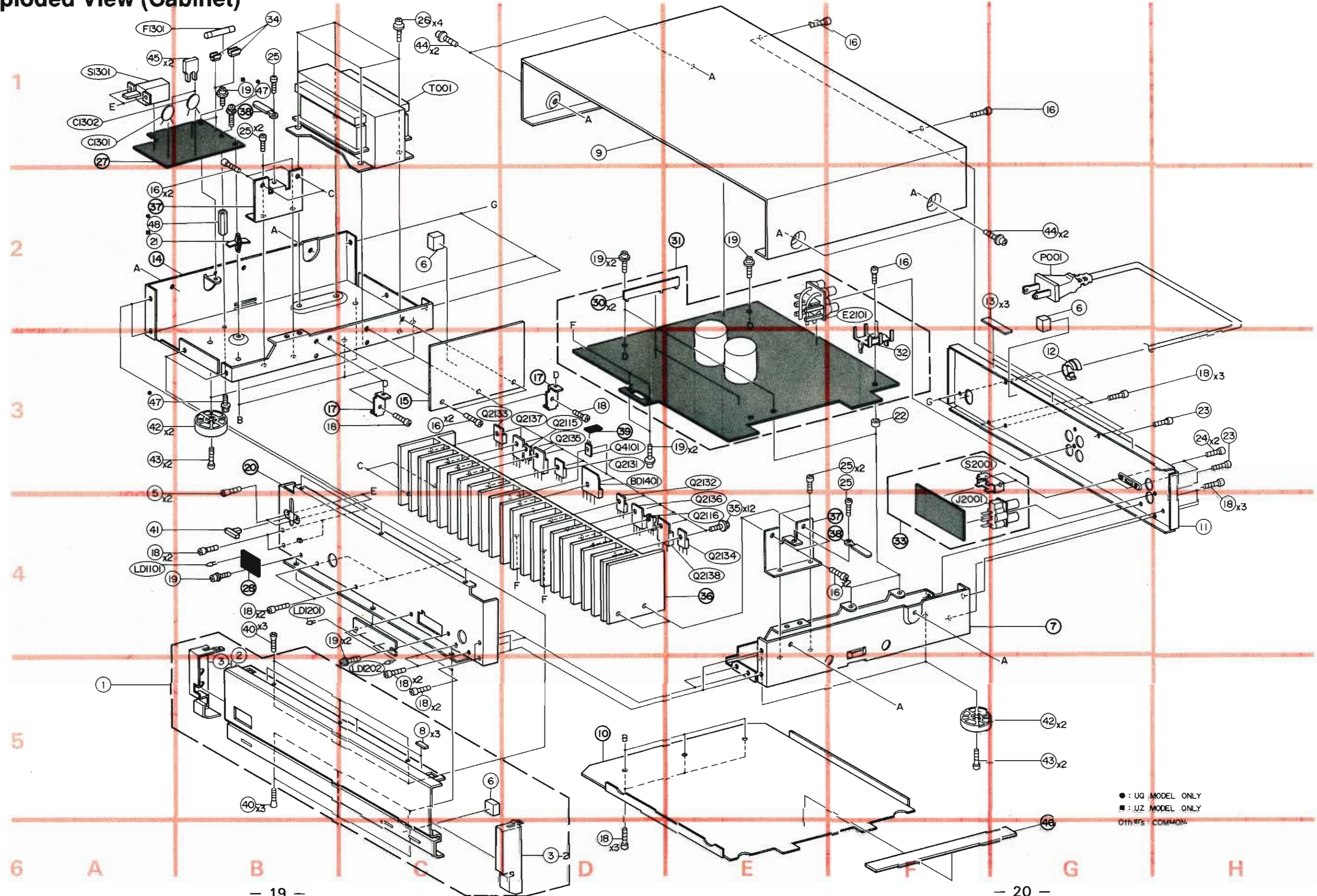

● : UQ MODEL ONLY
 ■ : UZ MODEL ONLY
 ○ □ : OTHERS - COMMON-

Packing Assembly Parts List

Symbol No.	Part No.	Description	Symbol No.	Part No.	Description
■ 101	68P96552F14	Owners.Manual M-113UZ			
● 101	68P96552F15	Owners.Manual M-113UQ			
102	56S10005W17	Carton.Packing M113UZ			
103	56D94704F01	Tray.Packing			
104	56B40442T08	Packing.Front Frame			
105	56B40230G08	Sack.Poly			

Note : ● ; For Canadian model only(UQ) ■ ; For North American model only(UZ) Others ; Common

Packing Method View

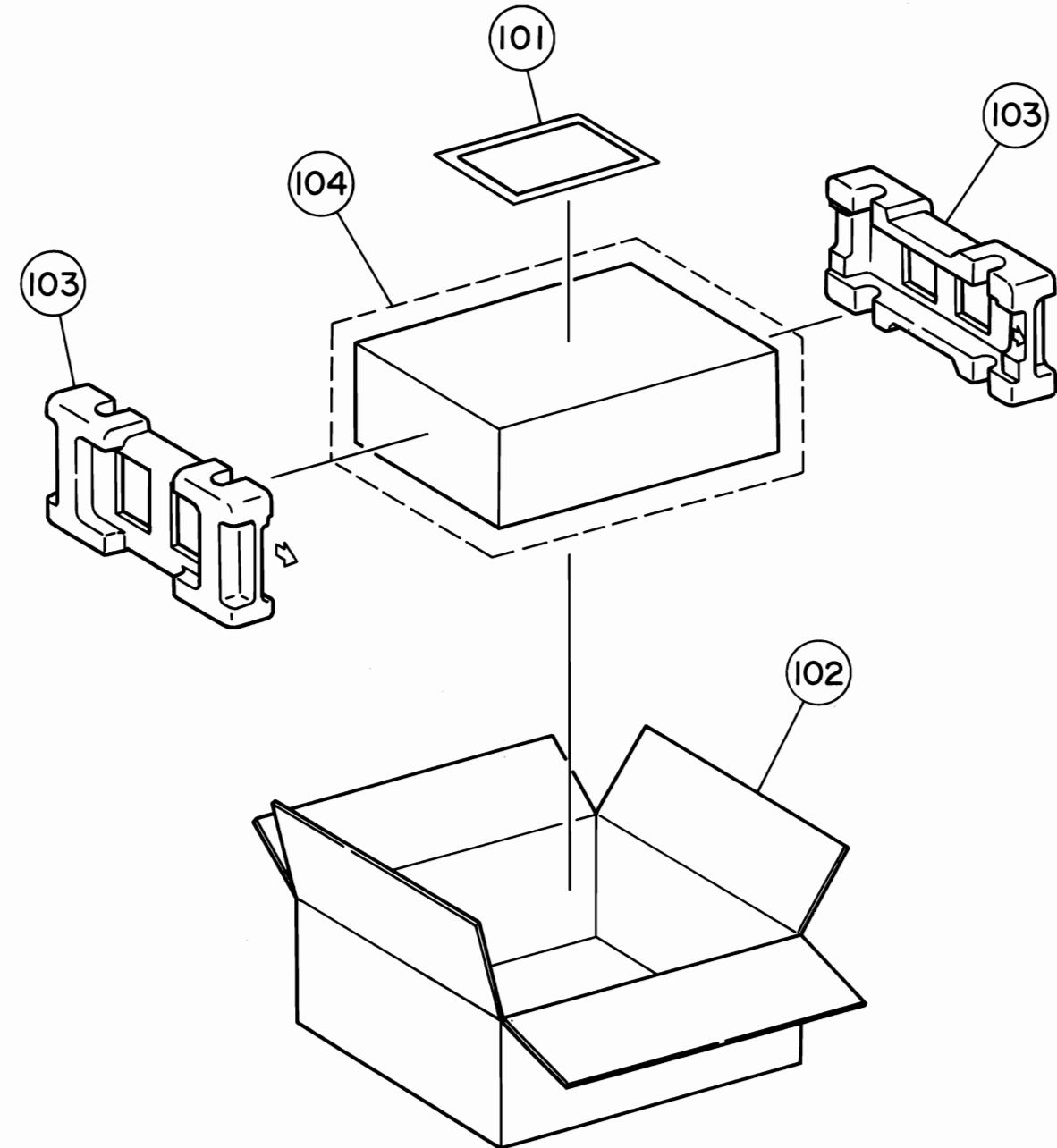



LUX CORPORATION, JAPAN

1-1-8 Nishi Gotanda, Shinagawa-ku, Tokyo, 141 JAPAN
Phone:03-493-4381 Facsimile:03-494-8426